

EV100H3N1K/EV101H3N1K

DC Fast Charger For Electric Vehicle Applications

Input: 260 – 530 Vac; Output: 150 – 1000Vdc (30kW@300 – 1000Vdc)



The EV100H3N1K/EV101H3N1K is a direct current fast-charger rectifier specifically designed to meet the unique needs in electric vehicle (EV) charger applications. The rectifier has a very wide output voltage range which starts from 150Vdc to 1000Vdc and can keep constant power of 30kW from 300Vdc to 1000Vdc with maximum output current of 100Adc. This broad output charging range combined with the rectifier's high operating efficiency – greater than 96% efficiency in optimum conditions – make it an ideal solution for current and future EV charging infrastructure. In addition, the rectifier's modular, self-contained, air-cooled chassis helps enable rapid serviceability and parallelable installations. EV charger once shutdown due to any protection, auto restart is not permitted unless system send restart command.

Application

- Electric Vehicle

Features

- Size: 300*84*435 millimeters or 11.81*3.31*17.13 inches (W*H*D, width not including mounting ears)
- Three-phase input nominal voltage: 400Vac/480Vac
- Output voltage of 150 to 1,000 – Volts DC (settable)
- Operating temperature range of -40 to 70°C
- Maximum output power of 30 kilowatts (kW) at 55°C
- Peak efficiency >96%
- Output High voltage mode (HV 150Vdc – 1000Vdc), Low voltage mode (LV 150Vdc – 500Vdc) operation (Fig.4)
- Power density: 44.8 W/inch³
- CANOpen communications
- Output over current protection and over voltage protection
- Input Under/over – voltage protection
- Over-temperature protection
- Remote firmware upgradable
- Design life is 10 years (with maintenance)
- cTUVus approval, CE mark available

Technical Specifications

Environmental Specifications

| Parameter | Min | Typ | Max | Units | Notes |
|--|-----|------------------|------|----------------|--|
| Ambient temperature | | | | | |
| Operating* | -40 | | +70 | °C | Derating from 55°C. Fig.1 |
| Storage | -40 | | +85 | °C | |
| Operating Altitude | | | 4000 | m | Derating from 2000m |
| Installation type | | | | | In IP54 cabinet |
| Cooling | | | | | Forced air cooling with FAN's |
| Expected life of fan | | 70,000 40,000 | | hours hours | Ambient temperature 45°C Ambient temperature 60°C |
| Pollution degree | | | | | PD2 |
| Humidity | | | | | |
| Operating | | | 95% | | Relative humidity, non-condensing |
| Storage | | | 95% | | Relative humidity, non-condensing |
| Coating | | | | | Conformal coating |
| MTBF | | 700,000 | | hours | Ambient temperature 40°C |
| Acoustic Noise | | 60.8 60.4 | | dB dB | Input 400Vac; Output LV 350V/Full load/Ambient temperature 35°C Input 400Vac; Output HV 750V/Full load/Ambient temperature 35°C |
| Vibration - sine sweep (non-operation) | | | | | IEC 60068-2-6 |
| Vibration - random (non-operation) | | | | | IEC60068-2-64 |
| Shock - half-sine (non-operation) | | | | | IEC60068-2-27 |
| Salt Mist | | | | | IEC60068-2-52 |

*below -20°C, output current will be automatically limited at startup and it will automatically increase to the target current after module internal temperature has warmed up.

Electrical items

AC specifications

| Parameter | Specification | Notes |
|------------------------|--|--|
| Grid Type | TN, TT | |
| AC rated input voltage | Three – phase Line – to – Line 400 Vac/ 480Vac | (AC input 3Wire + PE) |
| AC input voltage range | 260Vac~530Vac derating from 323Vac | Fig.2 |
| AC input frequency | 45-65Hz | |
| Maximum input current | 60 A | |
| Power factor | >0.99@ full load | rated input |
| Total harmonic current | < 5% @50% – 100% input current | rated input |
| Voltage unbalance | 10% unbalance (and still working nominal) | Single phase dip and up 10% Two phases dip and up 10% |
| Input impulse current | <110% rated current peak value | rated input |
| Input inrush current | <150% rated current peak value | rated input |

Technical Specifications (continued)

DC specifications

| Parameter | Specification | Notes |
|---|---------------------------------|--|
| Output voltage range | 150 – 1000Vdc | Fig.3 |
| Rated power | 30kW | |
| Maximum output current | 100 A | Fig.3 |
| Efficiency | ≥96% peak | rated input |
| voltage setting deviation | <0.5% | @half load |
| current setting deviation | ≤1% @Io≥30A; ≤0.3A @Io<30A | |
| Output voltage ripple | | Peak – to – peak, 20MHz bandwidth |
| @Input 400Vac; Output LV 350V/Full load/resistor load | 1.0V (typical) | Fig.5 |
| @Input 400Vac; Output HV 750V/Full load/resistor load | 1.4V (typical) | Fig.6 |
| Output current ripple | | Peak-to-peak, 150kHz bandwidth |
| @Input 400Vac; Output LV 350V/Full load/ with 5600uF cap | 2.2A (typical) | Fig.7 |
| @Input 400Vac; Output HV 750V/Full load/with 5600uF cap | 1.4A (typical) | Fig.8 |
| Current regular speed | 25A/s (typical) | from current value to target value |
| Voltage drop time after receiving stop command from CAN | ≤ 900ms to less than 60V | from current value to 60V |
| Voltage slew rate in normal operation | 1000V/s (typical) | |
| Voltage overshoot after load dump | < 110% of the requested voltage | IEC61851-23 ed2 clause 101.2.1.7 |
| Passive discharge | < 60V within 240seconds | |
| EPO Function | EV101 Product | Normally Closed, Signal Pins 3,4 12V ± 10% externally sourced |

Technical Specifications (continued)

Input protection

All the faults shall be transmitted to the external control unit via CAN.

| Parameter | Typical | Notes |
|------------------------------|----------|--|
| Under-voltage protection | 255±5Vac | PFC stage recover automatically, output restart need system send restart command |
| Over-voltage protection | 535±5Vac | PFC stage recover automatically, output restart need system send restart command |
| Voltage unbalance protection | ≥11% | PFC stage recover automatically, output restart need system send restart command |

Output protection

| Item | Typical | Notes |
|-------------------------|------------|---|
| Over voltage protection | 1050 ± 10V | Output restart need system send restart command |
| Short protection | 1.5 In | Output restart need system send restart command |

Characteristic Curves

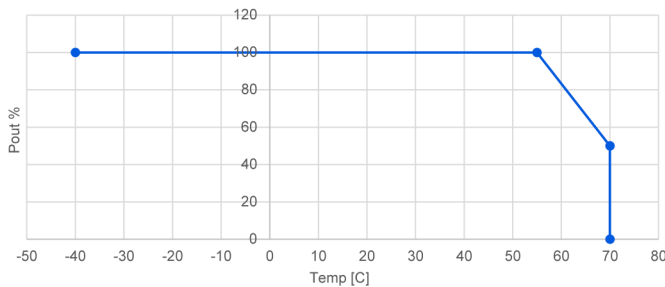

Fig.1 Temperature Limited Power Curve (Note1)

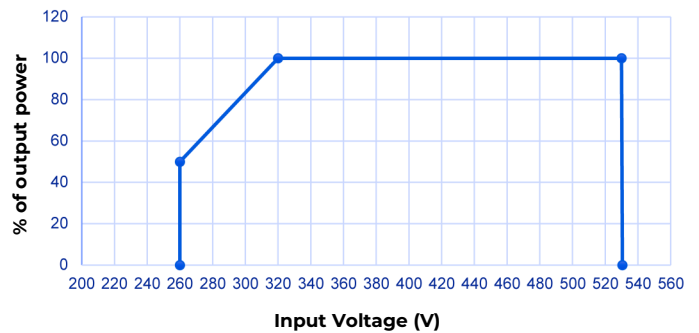

Fig.2 Input Limited Power Curve

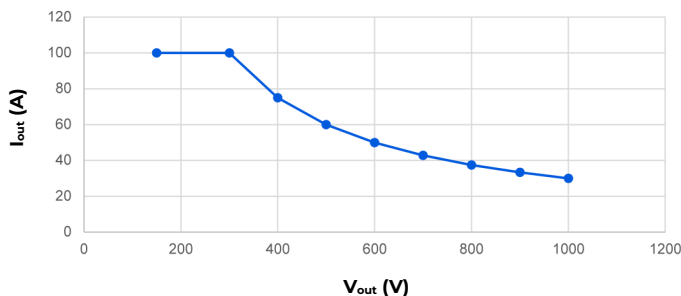

Fig.3 Output V-I Curve

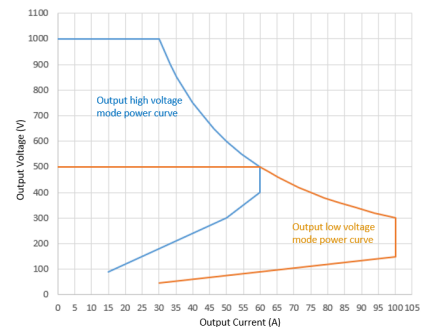
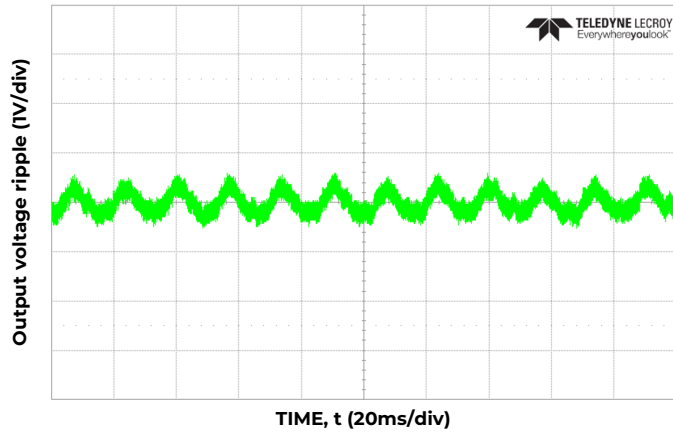

Fig.4 Output Power Curve for High Voltage Mode and Low Voltage Mode

Note 1: Power derating also occur if under some critical condition, power module's PFC stage reaches 98°C (at slope of 2.5kW/°C) or DC/DC stage reaches 106°C(at slope of 1.25kW/°C).

Technical Specifications (continued)

Characteristic Curves (Continued)



**Fig.5 Output voltage ripple @Input 400Vac; Output LV 350V/
Full load/resistor load**

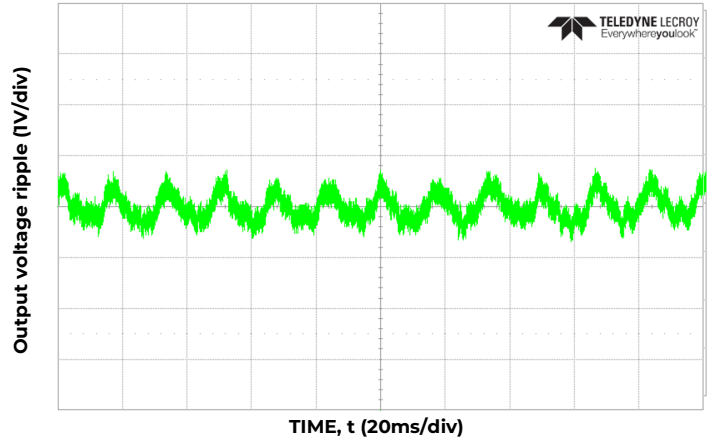

**Fig.6 Output voltage ripple @Input 400Vac; Output HV 750V/Full
load/resistor load**

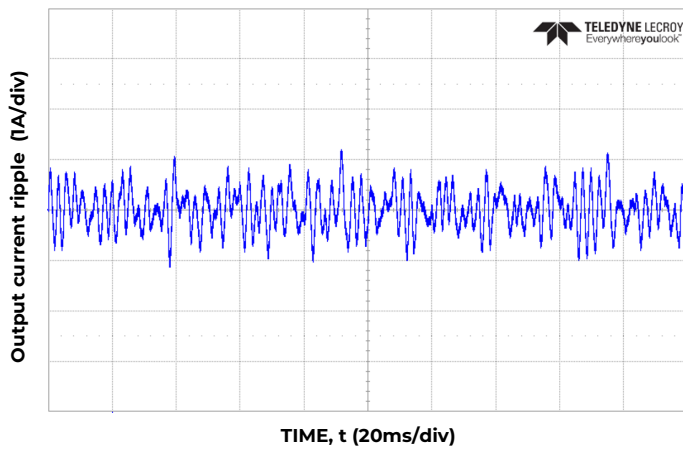

**Fig.7 Output current ripple @Input 400Vac; Output LV 350V/
Full load/with 5600uF capacitor**

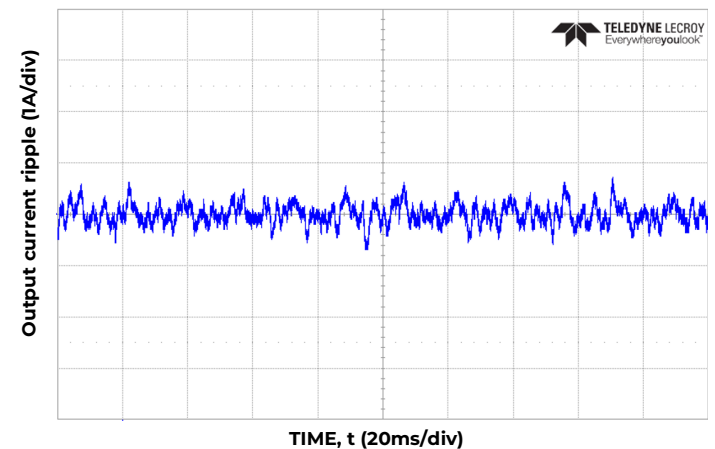

**Fig.8 Output current ripple @Input 400Vac; Output HV 750V/Full
load/with 5600uF capacitor**

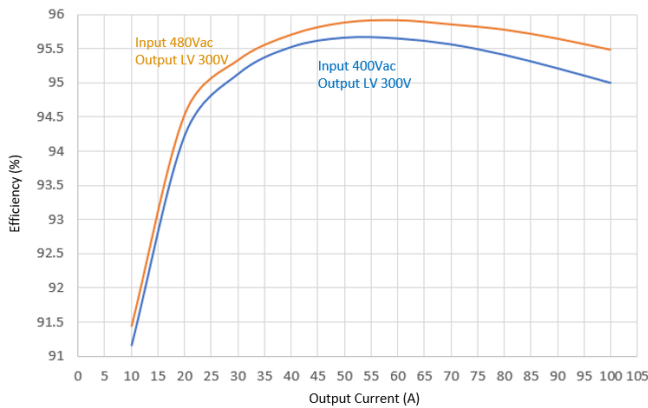

Fig.9 Rectifier Efficiency @ Output LV 300V

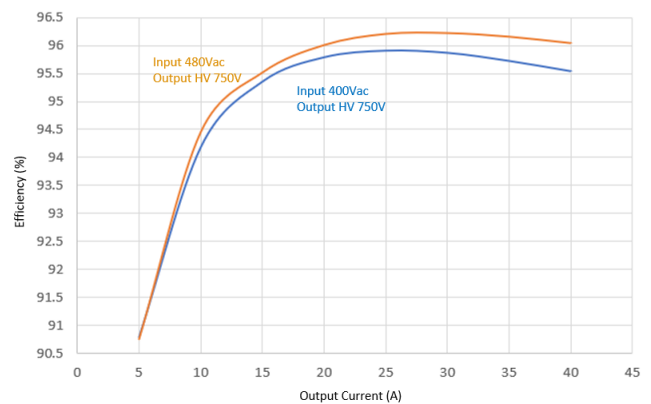

Fig.10 Rectifier Efficiency @ Output HV 750V

Technical Specifications (continued)

Characteristic Curves (Continued)

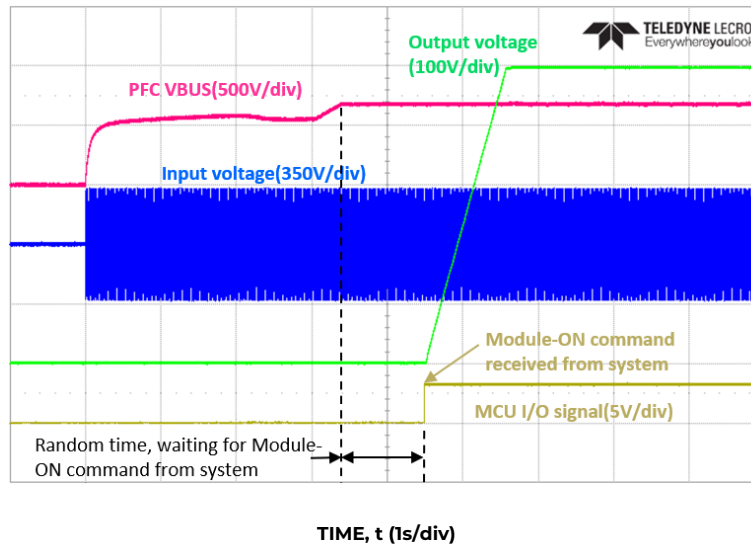

Fig.11 Power module start up @ Input 400Vac; Output HV 500V/no load

LED indicator

The warning signals of LED indicator are as below:

| Lamp | Status | Condition |
|------------------|-----------------------------|---|
| Green indicator | On | Normal operation |
| | Flashes twice in one second | Communication with monitor; DCDC OFF command is sent by monitor |
| Yellow indicator | On | Input AC under – voltage derating or temperature derating; Output current imbalance but still working; Module address conflict |
| | Off | Working normally |
| | Flashes twice in one second | Working in debug mode |
| Red indicator | On | Fan driver failure; AC input over – voltage/under – voltage; Internal over – temperature; Communication failure between PFC and DCDC; DC output over – voltage/under-voltage; CAN communication failure; AC input voltage phase loss; Over – current in DCDC primary side; Communication failure between CAN and DCDC; Output dummy load failure; Output over – current; Output relay failure; Output current imbalance |
| | Off | Without any failure |
| | Flashes twice in one second | Fan is blocked |

Technical Specifications (continued)

Insulation and Safety

| Parameter | Specification | Item | Standard | |
|------------------------------|-----------------|--------------|---------------------------------------|------------------------|
| Dielectric withstand voltage | Basic Isolation | AC-Enclosure | Test voltage according to IEC62477 | |
| | Reinforced | DC-Enclosure | Test voltage according to IEC62477 | |
| | Reinforced | AC – DC | Test voltage according to IEC62477 | |
| | Reinforced | AC – CAN | Test voltage according to IEC62477 | |
| | Reinforced | DC – CAN | Test voltage according to IEC62477 | |
| Leakage current | <1.25mA (<1kHz) | | | |
| Over voltage Category | | | Ovc III – ac port Ovc II – dc port | According IEC62477 – 1 |

Safety Certification

| Region | Safety standard | Marking |
|---------------|---|---------|
| North America | UL2202, UL2231 | |
| Europe | IEC60664-1: 2007 IEC/EN 61851-23 IEC61851-1 | |

Electro-Magnetic Compatibility

| Parameter | Function | Standards | Levels | Criterion | Notes |
|--|---------------------------------------|---|--|--------------|---------|
| EMI | Conducted Emission (Note2) | IEC61851-21-2 EN55032 FCC part 15 class A | CLASS A | / | AC port |
| | Radiated Emission (Note2) | IEC61851-21-2 EN55032 FCC part 15 class A | CLASS A | / | |
| | Harmonic Current Emission | IEC61000-3-2 | A class equipment | / | |
| | Voltage fluctuation and Flicker | IEC61000-3-3 | $P_{st} \leq 1.0$, $P_{it} \leq 0.65$, $d_c \leq 3\%$, $d_{max} \leq 4\%$ the value of $d(t)$ during a voltage change shall not exceed 3% for more than 200ms | / | |
| EMS | Immunity to Electrostatic Discharge | IEC61000-4-2 | Air discharge 15kV | | |
| | | | Contact discharge 8kV | | |
| | Immunity to Radiated Electric Fields | IEC61000-4-3 | 20V/m | A | |
| | Immunity to Power Frequency Magnetic | IEC61000-4-8 | 100A/m | A | |
| | Immunity to Electrical Fast Transient | IEC61000-4-4 | 2KV | B | |
| | Immunity to surges | IEC61000-4-5 | Differential mode: 2kV | B | |
| | | | Common mode : 4kV | | |
| Immunity to Continuous Conducted Interference | IEC61000-4-6 | 20Vrms | A | | |
| Immunity to Voltage Dips and short interruptions | IEC61000-4-11 | | B | 380Vac input | |

Criterion A: the output voltage should be in the regulation band during the test.
 Criterion B: the power module is allowed to lose its function. Namely, it can shut off its output during the test. However, it must recover automatically after the condition is normal.
 Criterion C: the power module is allowed to lose its function. Namely, it can shut off its output during the test. However, it must be able to recover after manpower's intervention.

Note 2: Conducted Emission and Radiated Emission are complied testing in system.

Technical Specifications (continued)

Mechanical features

Weight

| Parameter | Min | Typ | Max | Units | Notes |
|-----------|-----|------|-----|-------|-------|
| Weight | | 14.3 | 15 | kg | |

Mechanical outline

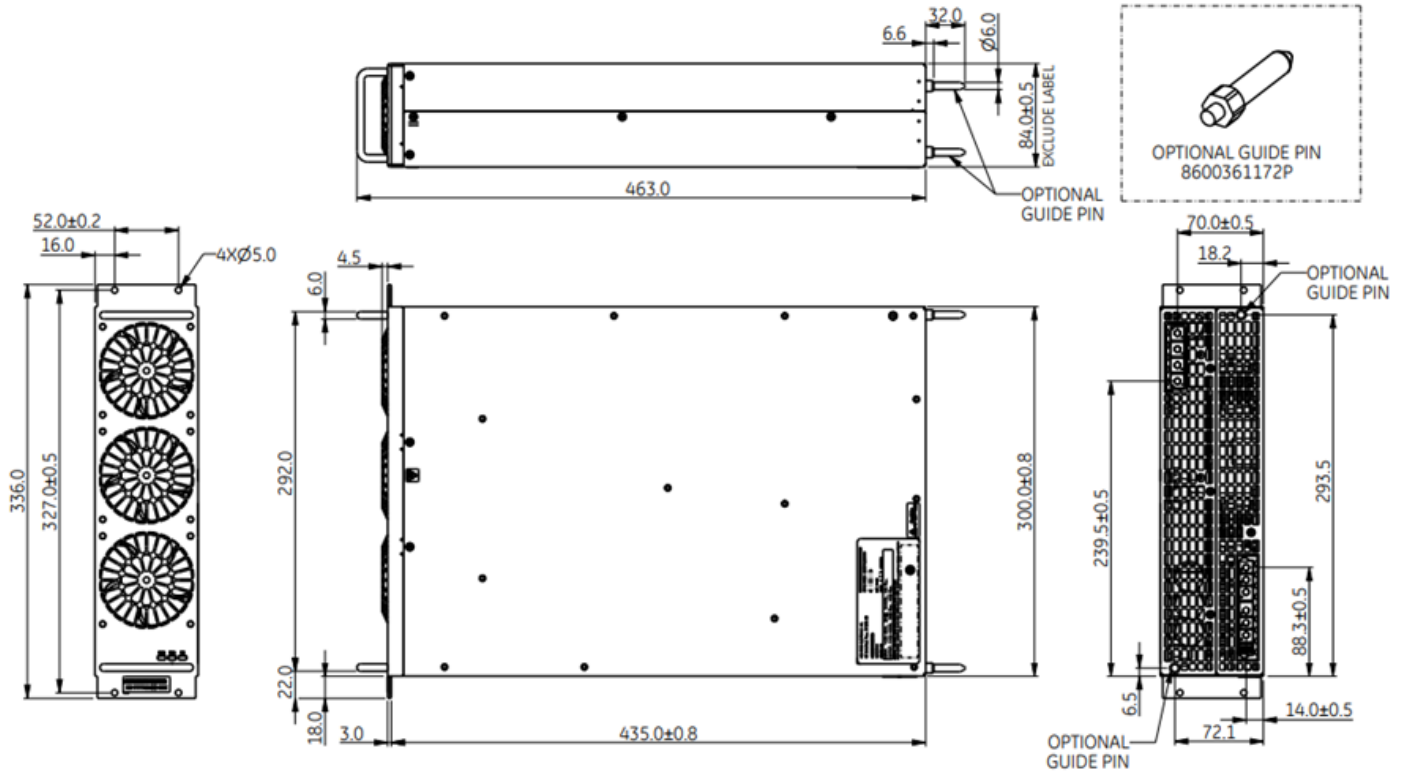

Front panel

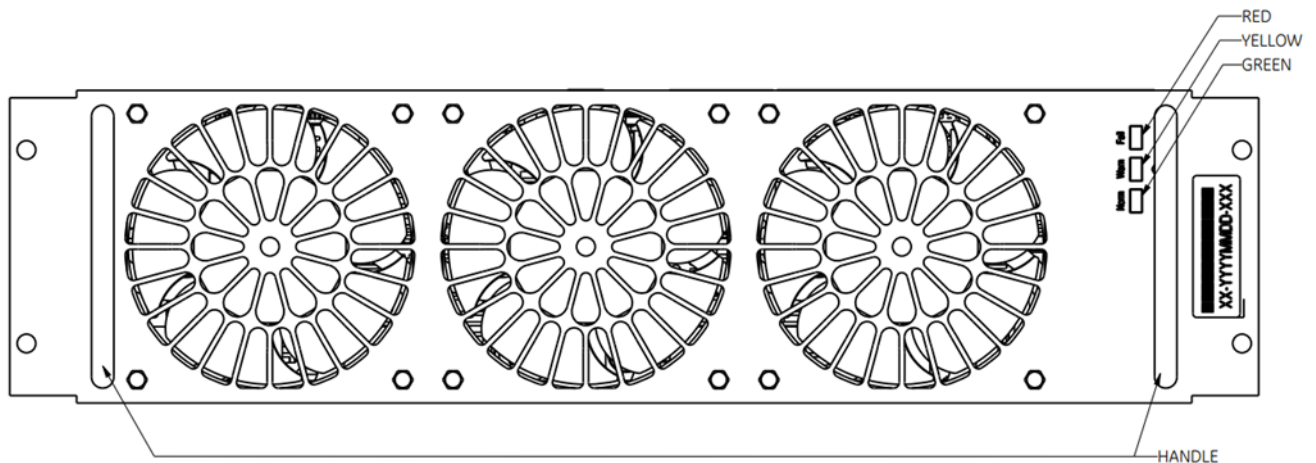

Technical Specifications (continued)

EV100H3N1K/ EV101H3N1K Connector

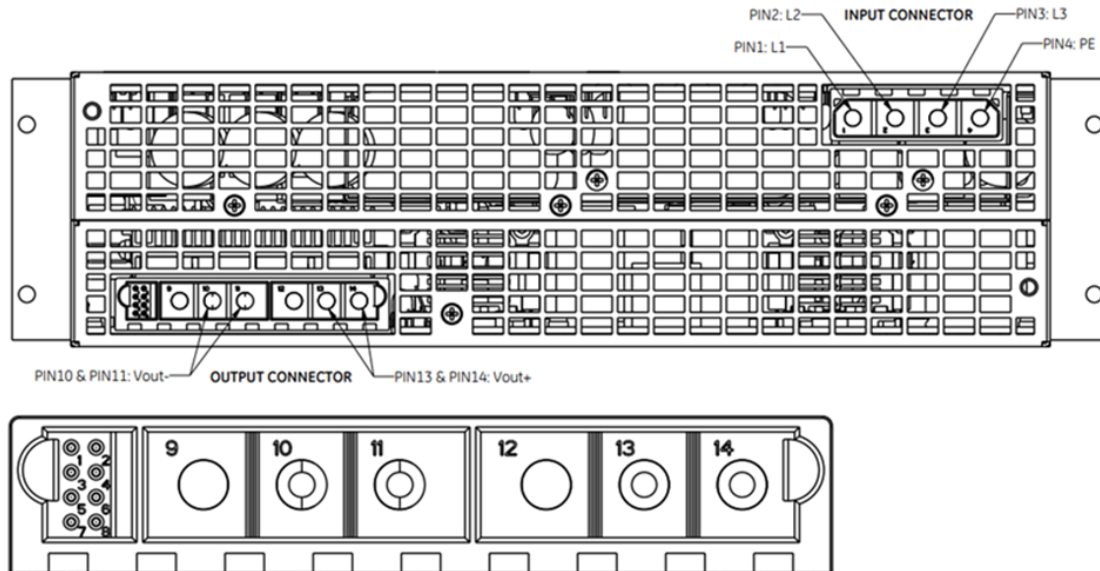

Connector Information

| Connectors | Part No. | Vendor |
|---------------------|--------------------------|--------------------------|
| AC Input Connector | RPS0400008(Amphenol FCI) | RPS0415008(Amphenol FCI) |
| DC Output Connector | RPS1402008(Amphenol FCI) | RPS1415008(Amphenol FCI) |

Pinout Information for EV100H3N1K – Without EPO

| AC Input Connector | | DC Output Connector | |
|--------------------|----|---------------------|-------------|
| PIN 1 | L1 | PIN 1 | CANH |
| PIN 2 | L2 | PIN 2 | CANL |
| PIN 3 | L3 | PIN 5 | Address_GND |
| PIN 4 | PE | PIN 7 | Address 1 |
| | | PIN 8 | Address 2 |
| | | PIN 10 | VOUT - |
| | | PIN 11 | VOUT - |
| | | PIN 13 | VOUT + |
| | | PIN 14 | VOUT + |

Pinout Information for EV101H3N1K – With EPO

| AC Input Connector | | DC Output Connector | |
|--------------------|----|---------------------|-------------|
| PIN 1 | L1 | PIN 1 | CANH |
| PIN 2 | L2 | PIN 2 | CANL |
| PIN 3 | L3 | PIN 3 | EPO + |
| PIN 4 | PE | PIN 4 | EPO - |
| | | PIN 5 | Address_GND |
| | | PIN 7 | Address1 |
| | | PIN 8 | Address2 |
| | | PIN 10 | Vout - |
| | | PIN 11 | Vout - |
| | | PIN 13 | Vout + |
| | | PIN 14 | Vout + |

The EV101H3N1K supports EPO function (Emergency Power Off) using discrete pins.

The pins are normally high, provided by auxiliary voltage from the charger. When the circuit is opened, the rectifier shuts off within 50ms.

Refer Table EPO operating sequence for EPO electrical details.

Technical Specifications (continued)

EPO Specification

| | |
|-------------------------|--|
| Signal pins | 3(+) & 4(-) |
| Input power consumption | <5mA |
| DC output | |
| Enable | By applying +12V \pm 10% |
| Disable | By removing 12V or ground Output Disabled <50ms |
| EPO Input Isolation | |
| Against AC & DC | Reinforced isolation |
| Against Enclosure | Basic isolation |

- EPO function is part of the same isolation group as the CAN interface.
- The EPO signal is reported through the alarm register.

AC input mating connector cable

The length of AC input mating connector cable is around 1500 millimetres. Refer below image.

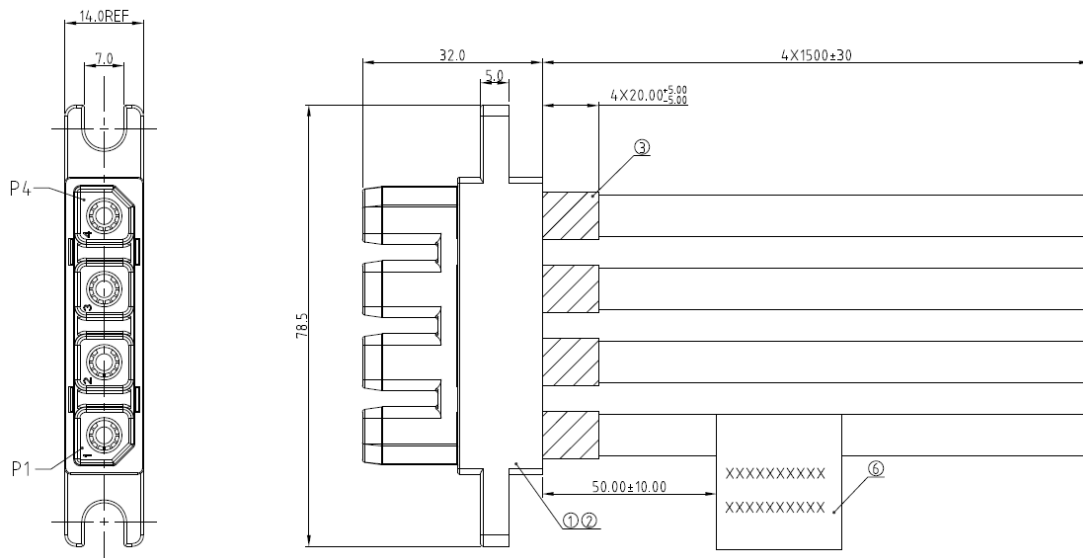
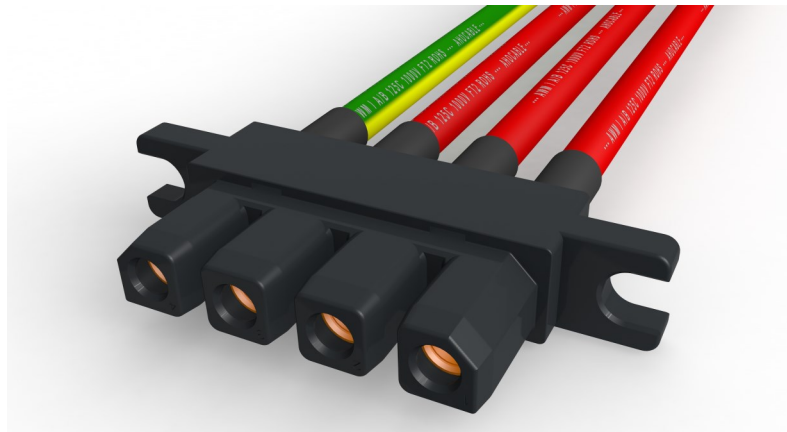

AC input mating connector cable

Technical Specifications (continued)

DC output mating connector cable

The length of DC output mating connector cable is around 1500 millimetres. Refer below image.

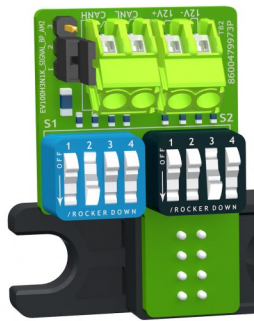
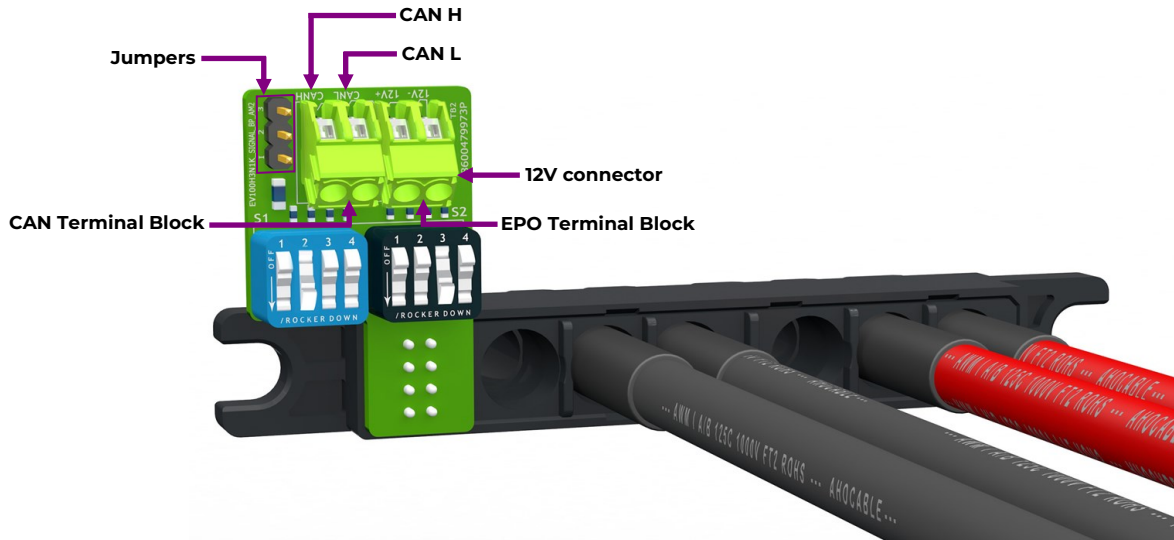

Jumper pins 1-2 Pass through



Jumper pins 2-3 120 Ohm

DC Output Cable embedded Can bus interface – back view

Note:

12V signal applied to the 12V connector powers the EPO circuit when using EV101.
12V connector is not used when connected to EV100.

| Jumper Position | Function |
|------------------------------|--|
| No jumper | The function same with jumper on 1-2 pins. This photo is for show the header and pin sequence. |
| 2 – 3 (far away from dip sw) | 120Ω resistor on |
| 1 – 2 (close to dip sw) | 120Ω resistor off |

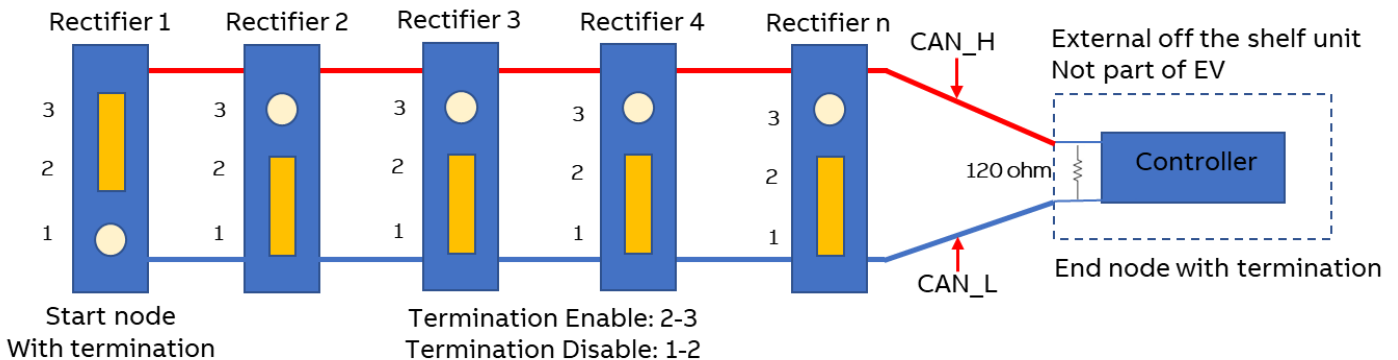

Technical Specifications (continued)

Drawing code address on Address board

Hardware address = 5* (the “ON” digital position of S2 + the “ON” digital position of S1)

Example: S1 NO.2 is “ON”, S2 NO.3 is “ON”

Hardware address = 5*3+2 = 17

Note: If no any digital position is “ON”, the default is zero.

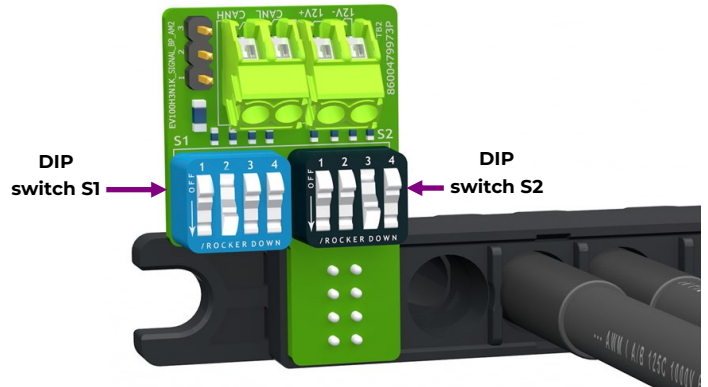

Dial code comparison table

FORMULA used: $5*S2_X + S1_Y > (X=1..4; Y=1..4)$

| Position/HW address | S1 Value | S2 Value | S1 | | | | S2 | | | |
|---------------------|----------|----------|-----|-----|-----|-----|-----|-----|-----|-----|
| | | | _1 | _2 | _3 | _4 | _1 | _2 | _3 | _4 |
| 1 | 1 | 0 | ON | OFF | OFF | OFF | OFF | OFF | OFF | OFF |
| 2 | 2 | 0 | OFF | ON | OFF | OFF | OFF | OFF | OFF | OFF |
| 3 | 3 | 0 | OFF | OFF | ON | OFF | OFF | OFF | OFF | OFF |
| 4 | 4 | 0 | OFF | OFF | OFF | ON | OFF | OFF | OFF | OFF |
| 5 | 0 | 1 | OFF | OFF | OFF | OFF | ON | OFF | OFF | OFF |
| 6 | 1 | 1 | ON | OFF | OFF | OFF | ON | OFF | OFF | OFF |
| 7 | 2 | 1 | OFF | ON | OFF | OFF | ON | OFF | OFF | OFF |
| 8 | 3 | 1 | OFF | OFF | ON | OFF | ON | OFF | OFF | OFF |
| 9 | 4 | 1 | OFF | OFF | OFF | ON | ON | OFF | OFF | OFF |
| 10 | 0 | 2 | OFF | OFF | OFF | OFF | OFF | ON | OFF | OFF |
| 11 | 1 | 2 | ON | OFF | OFF | OFF | OFF | ON | OFF | OFF |
| 12 | 2 | 2 | OFF | ON | OFF | OFF | OFF | ON | OFF | OFF |
| 13 | 3 | 2 | OFF | OFF | ON | OFF | OFF | ON | OFF | OFF |
| 14 | 4 | 2 | OFF | OFF | OFF | ON | OFF | ON | OFF | OFF |
| 15 | 0 | 3 | OFF | OFF | OFF | OFF | OFF | OFF | ON | OFF |
| 16 | 1 | 3 | ON | OFF | OFF | OFF | OFF | OFF | ON | OFF |
| 17 | 2 | 3 | OFF | ON | OFF | OFF | OFF | OFF | ON | OFF |
| 18 | 3 | 3 | OFF | OFF | ON | OFF | OFF | OFF | ON | OFF |
| 19 | 4 | 3 | OFF | OFF | OFF | ON | OFF | OFF | ON | OFF |
| 20 | 0 | 4 | OFF | OFF | OFF | OFF | OFF | OFF | OFF | ON |
| 21 | 1 | 4 | ON | OFF | OFF | OFF | OFF | OFF | OFF | ON |
| 22 | 2 | 4 | OFF | ON | OFF | OFF | OFF | OFF | OFF | ON |
| 23 | 3 | 4 | OFF | OFF | ON | OFF | OFF | OFF | OFF | ON |
| 24 | 4 | 4 | OFF | OFF | OFF | ON | OFF | OFF | OFF | ON |

1. When setting the address, ensure that at most one dip switch of S1 or S2 is in the “ON” state, if more than one dip switch of S1 or S2 is in the “ON” state, hardware address calculation errors may occur.
2. If all the dial code of S1 and S2 are “OFF”, which indicates invalid address.
3. The colors S1 and S2 dip switches are blue and black.

Technical Specifications (continued)

Ordering Information

| Ordering Code | Description | Input Nominal Voltage | Output Voltage Range | Output Current | Temperature Range |
|---------------|---|-----------------------------|----------------------|----------------|-------------------|
| 1600293422A | EV100H3N1K 30kW DC Fast Charger Rectifier without EPO | 400Vac/480 Vac, 3Wire+PE | 150 - 1000Vdc | 100A dc max | -20°C to 70°C |
| 1600469352A | EV101H3N1K 30kW DC Fast Charger Rectifier with EPO | | | | |

Accessories

| Ordering Code | Description |
|---------------|---|
| 4600400617P | 4 POLES AC INPUT CABLE FOR EV, 6AWG |
| 7000450144A | 8S+4P DC CABLE FOR EV, 6AWG |
| 1600449585A | CABLE KIT EV100H3N1K/EV101H3N1K CABLE SETS, contains 1 AC cable and 1DC cable |
| 1600441222A | CANopen toolkit |

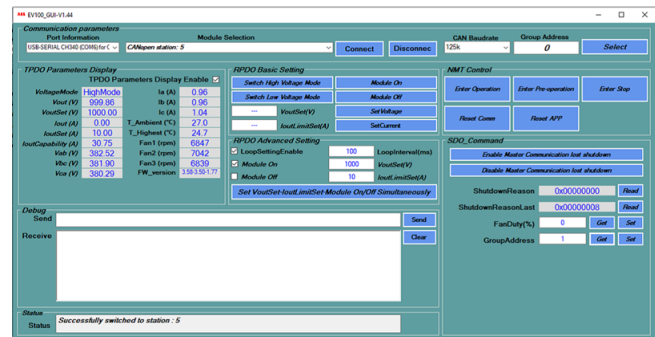

Change History (excludes grammar & clarifications)

| Version | Date | Description of the change |
|---------|------------|---|
| 1.0 | 06/15/2021 | Initial Release |
| 1.1 | 01/20/2022 | Update dimension, output voltage slew rate; add MTBF, fan life, conformal coating, remote firmware upgradable, salt mist; |
| 1.2 | 10/06/2022 | Added details for EV101H3N1K |
| 1.3 | 11/18/2022 | Added EPO terminal block to figures (p.11,12) |
| 1.4 | 9/20/2023 | Re-branded OmniOn Power |
| 1.5 | 11/21/2023 | Updated as per OmniOn template |

OmniOn Power Inc.

601 Shiloh Rd.
Plano, TX USA

omnionpower.com

We reserve the right to make technical changes or modify the contents of this document without prior notice. OmniOn Power does not accept any responsibility for errors or lack of information in this document and makes no warranty with respect to and assumes no liability as a result of any use of information in this document.

We reserve all rights in this document and in the subject matter and illustrations contained therein. Any reproduction, disclosure to third parties or utilization of its contents – in whole or in parts – is forbidden without prior written consent of OmniOn Power. This document does not convey license to any patent or any intellectual property right. Copyright© 2023 OmniOn Power Inc. All rights reserved.