

General Description

TMR1343 is a digital omnipolar magnetic switch that integrates TMR and CMOS technology in order to provide a magnetically triggered digital switch with high sensitivity, high speed, and ultra-low power consumption. It is designed for use in applications that are both power-critical and performance-demanding. It contains a push-pull half-bridge TMR magnetic sensor and CMOS signal processing circuitry within the same package, including an on-chip TMR voltage generator for precise magnetic sensing, a TMR voltage amplifier and comparator plus a Schmitt trigger to provide switching hysteresis for noise rejection, and CMOS push-pull output. An internal band gap regulator is used to provide a temperature compensated supply voltage for internal circuits, permitting a wide range of supply voltages. The TMR1343 draws only 1.5µA resulting in ultra-low power operation. It has fast response, accurate switching points, excellent thermal stability, and immunity to stray field interference. It is available in the LGA2x1.5x0.63 -3Lpackage.

Features and Benefits

- Tunneling Magnetoresistance (TMR) Technology
- Ultra Low Power Consumption at 1.5uA
- High Frequency Response > 1kHz
- Operation with North or South Pole
- Low Switching Points for High Sensitivity
- Compatible with a Wide Range of Supply Voltages
- Excellent Thermal Stability
- High Tolerance to External Magnetic Field Interference
- Super small size package LGA2x1.5x0.63 -3L

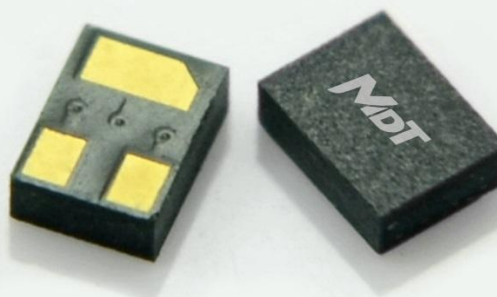

TMR1343

Applications

- Utility Meters including Water, Gas, and Heat Meters
- Proximity Switches
- Position and Speed Sensing
- Motor and Fan Control

Block Diagram

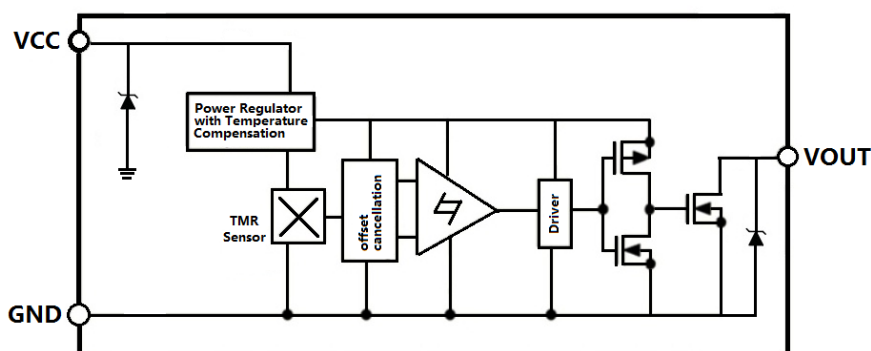

Pin Configuration

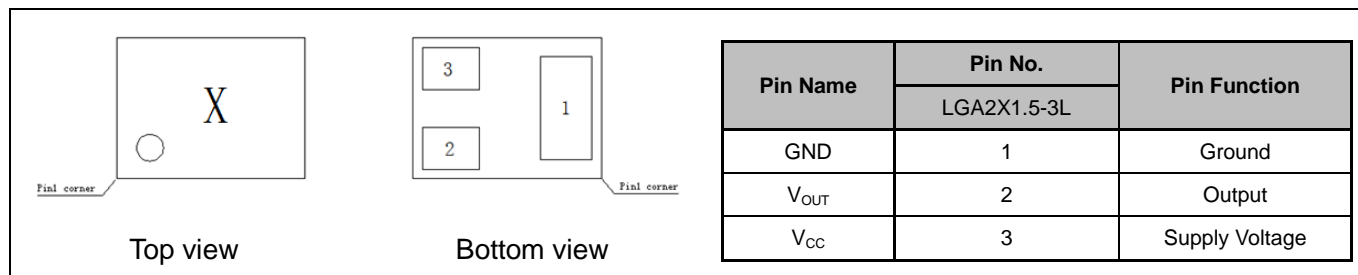

Absolute Maximum Ratings

| Parameter | Symbol | Limit | Unit |
|-------------------------------|----------------------|-----------|------|
| Supply Voltage | V _{CC} | 7 | V |
| Reverse Supply Voltage | V _{RCC} | 0.3 | V |
| Output Current | I _{OUTSINK} | 20 | mA |
| Magnetic Flux Density | B | 2800 | G |
| ESD level(HBM) | V _{ESD} | 2 | kV |
| Operating Ambient Temperature | T _A | -40 ~125 | °C |
| Storage Temperature | T _{stg} | -50 ~ 150 | °C |

Electrical Characteristics (V_{CC}=3.0V, T_A=25°C)

| Parameter | Symbol | Conditions | Min | Typ. | Max | Unit |
|------------------------------|---------------------|---|-----|------|-----|------|
| Supply Voltage | V _{CC} | Operating | 1.5 | 1.8 | 5.5 | V |
| Output Stress Voltage | V _{stress} | | | | 5.5 | V |
| Output leak Current | I _{leak} | OUT=H, V _{CC} =3V, V _{out} =3V | | | 1 | uA |
| Output Resistance of Turnoff | R _{off} | OUT=H | | 10 | | MΩ |
| Output Low Voltage | V _{OL} | OUT=L, V _{CC} =3V, I _{sink} =10mA | 0 | | 0.1 | V |
| Output Resistance of Turn on | R _{on} | OUT=L | | | 10 | Ω |
| Supply Current | I _{CC} | Output Open | | 1.5 | | uA |
| Response Frequency | F | | | 1000 | | Hz |

Note: a 1kOhm pull-up resistor is connected between V_{CC} and V_{OUT}, a 100nF capacitor is connected between V_{CC} and GND during all tests in the above table.

Magnetic Characteristics (V_{CC} = 3.0V, T_A = 25°C)

| Parameters | Symbol | Min | Typ. | Max | Units |
|---------------|------------------|-----|------|-----|-------|
| Operate Point | B _{OPS} | | 50 | | G |
| | B _{OPN} | | -50 | | G |
| Release Point | B _{RPS} | | 45 | | G |
| | B _{RPN} | | -45 | | G |
| Hysteresis | B _H | | 5 | | G |

Voltage Characteristics

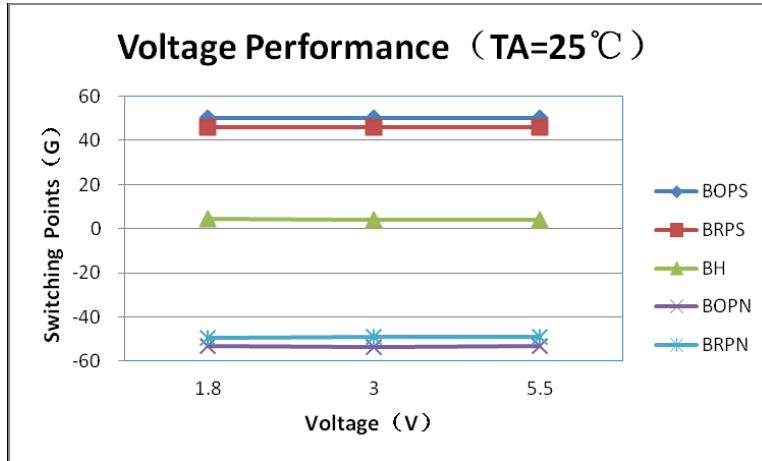

Output Behavior vs. Magnetic Pole

| Parameter | Test Conditions | Output |
|------------|-------------------|------------|
| South Pole | $B > B_{OPS}$ | Low (On) |
| | $0 < B < B_{RPS}$ | High (Off) |
| North Pole | $B < B_{OPN}$ | Low (On) |
| | $0 > B > B_{RPN}$ | High (Off) |

Note: when power is turned on under zero magnetic field, the output is "High".

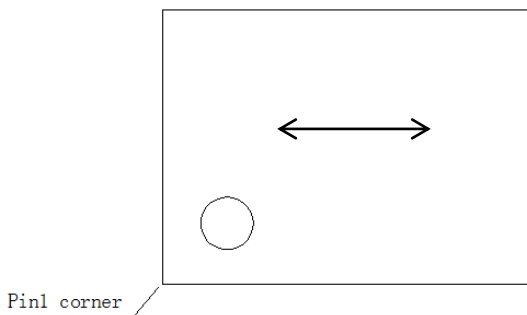

Sensing Direction of Magnetic Field

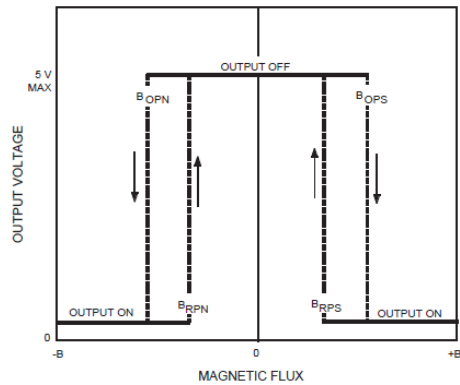

Magnetic Flux

Application Information

The output of the TMR1343 switches low (turns on) when a magnetic field to the sensing axis exceeds the operate point threshold, B_{OP} . When the magnetic field is reduced below the release point, B_{RP} , the device output switches high (turns off). The difference between the B_{OP} and B_{RP} is the hysteresis B_H of the device.

It is strongly recommended that an external bypass capacitor be connected in close proximity to the device between the supply and ground pins to reduce noise. The recommended value for the external bypass capacitor is 0.1µF.

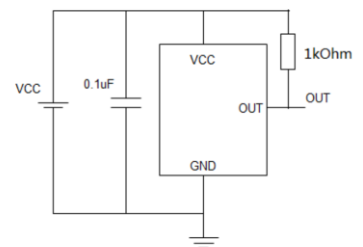

Package Information

LGA2x1.5 -3Lpackage drawing

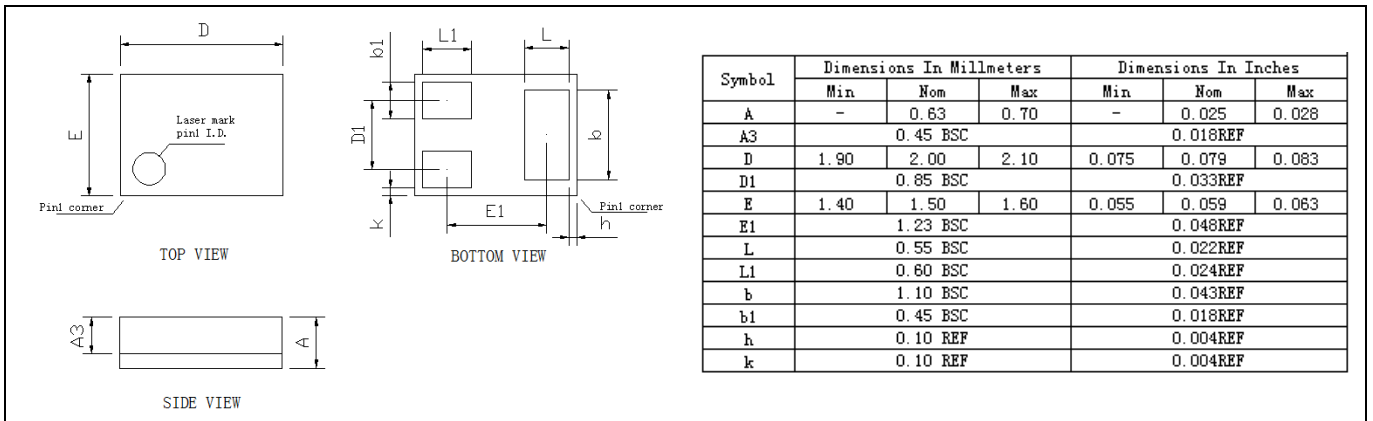

TMR Sensor Position

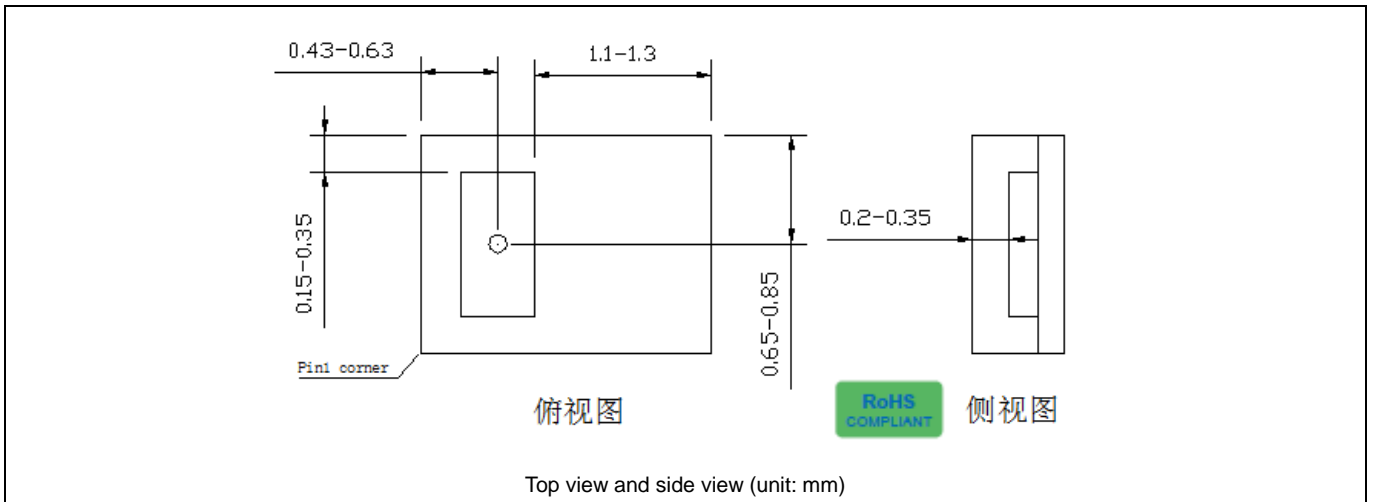



MultiDimension Technology Co., Ltd.

Address: No.7 Guangdong Road, Zhangjiagang Free Trade Zone, Jiangsu, 215634, China

Web: www.dowaytech.com/en

Email: info@dowaytech.com

The information provided herein by MultiDimension Technology Co., Ltd. (hereinafter MultiDimension) is believed to be accurate and reliable. Publication neither conveys nor implies any license under patent or other industrial or intellectual property rights. MultiDimension reserves the right to make changes to product specifications for the purpose of improving product quality, reliability, and functionality. MultiDimension does not assume any liability arising out of the application and use of its products. MultiDimension's customers using or selling this product for use in appliances, devices, or systems where malfunction can reasonably be expected to result in personal injury do so at their own risk and agree to fully indemnify MultiDimension for any damages resulting from such applications.