

# SmartPower Stacks™ Spec Sheet

## Level 2M: 100 kW DC-AC Inverter

### Key Data

3 Phase Inverter Configuration

Rated output: 100kW

### General Information

Standard configuration includes: (3) IGBT Modules, (3) Gate Drive Boards, (3) Current Sensors, Interface Board, Heat Sink and Integrated DC bus Capacitor

<b>Topology</b>	3 Phase Inverter (B6I)
<b>Application / Modulation</b>	Inverter / Sine or Custom
<b>Load Type</b>	Resistive, Inductive
<b>Standards</b>	UL certification pending
<b>Cooling</b>	Forced Air (fan optional)
<b>Markets</b>	Solar, Wind, UPS, Battery Storage, Motor Control, Power Conversion Applications.
<b>Current Sensors</b>	LEM – HASS 400-S
<b>IGBT Modules</b>	FUJI – Electric DualXT – 2MBI450VN-120-50
<b>Gate Drive Boards</b>	AgileSwitch – AS2-20D1ANPU-FE450VN12
<b>Interface Board</b>	AgileSwitch – ASI-PS
<b>Heat Sink</b>	Methode – High Performance Extruded
<b>DC Link Capacitors</b>	Methode – Capacitor Bank

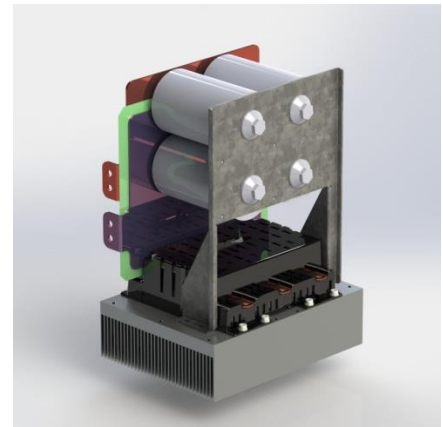

### SmartPower Stack Topology

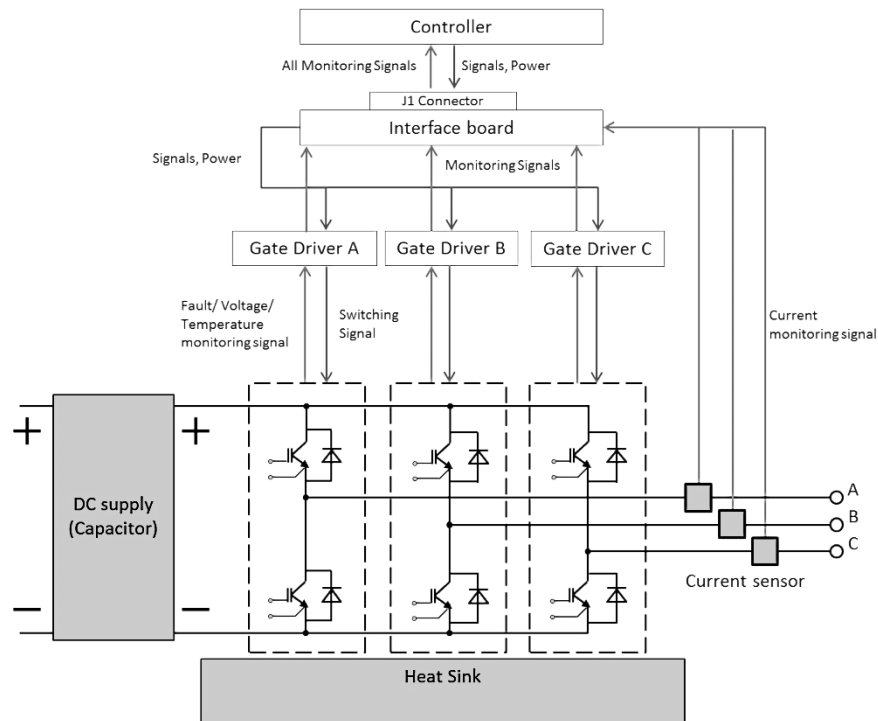

\* Controller Optional

<b>Prepared by:</b> Yueheng Guo	<b>Version:</b> v1.0
<b>Approved by:</b> Albert Charpentier	<b>Effective Date:</b> 2/14/2013

# SmartPower Stacks™ Spec Sheet

## Level 2M: 100 kW DC-AC Inverter

### Note: Typical Operating Conditions:

$V_{DC}=700$ ,  $V_{AC}=480$ ,  $F_{SW}=5\text{kHz}$ ,  $\text{Cos}(\varphi)=.9$ , airflow = 485 m<sup>3</sup>/hr, air temp = 25°C,  $I_{AC}=150 A_{RMS}$

### Electrical Characteristics

DC Link	Notes	Symbol	min	typ	max	unit
DC link Voltage	Continuous Operation	$V_{DC}$	280		900	V
Max Surge Voltage	2 min, non-operational				1200	V
Overvoltage Shutdown	Configurable		700	900	1000	V
Capacitance	See separate datasheet for details	Methode Capacitor Bank datasheet				
Capacitor ESL	See separate datasheet for details	Methode Capacitor Bank datasheet				

AC Data	Notes	Symbol	min	typ	max	unit
Voltage		$V_{AC}$	280		900	$V_{rms}$
Continuous Current	See Typical Operating Conditions	$I_{AC}$			400	$A_{rms}$
Power Loss	See Typical Operating Conditions	$P_{loss}$		1800		W
Switching Freq <sup>1</sup>	See Typical Operating Conditions Max frequency is @ 50°C	$F_{SW}$		5	10	kHz
Power Factor	Leading or Lagging	$\text{Cos}(\varphi)$	0		1	
Surge Current	Max for 10 μs				900	$A_{rms}$

General Data	Notes	Symbol	min	typ	max	unit
Insulation Test Voltage				4		kV

### Heat Sink Air Cooled/Thermal Data

Data	Notes	Symbol	min	typ	max	unit
Airflow	See Typical Operating Conditions	$\Delta V/\Delta t_{Air}$		485		m <sup>3</sup> /hr
Air Pressure Drop		$\Delta P_{Air}$		410		Pa
Cooling Air Inlet Temperature	Typical Operating Conditions are supported over this operating range, including Tmax.	$T_{inlet}$	-25	25	50	°C

### Environmental Conditions

Data	Notes	Symbol	min	typ	max	unit
Storage Temp	Non-operational	$T_{stor}$	-40		85	°C
Ambient Temp	Continuous Operation Note: different from Tinlet	$T_{Amb}$	-25		50	°C
Altitude above sea level	Derated operation possible above Alt Max	Alt			1000	m
Air Pressure	Standard Atmosphere	$P_{air}$	900		1100	hPa
Humidity	Non-condensing	Rel. F	5		85	%
Total Weight	Without capacitor			13		kg
Weight w/o Heat Sink	Without capacitor			7.6		kg
Dimensions	L x W x H (Without capacitor)		280	215	165	mm
Heat Sink Dimensions	L x W x H		280	215	80	mm
Torque at AC terminals		$M_{AC}$	16		20	Nm

Prepared by: Yueheng Guo	Version: v1.0
Approved by: Albert Charpentier	Effective Date: 2/14/2013

# SmartPower Stacks™ Spec Sheet

## Level 2M: 100 kW DC-AC Inverter

### IGBT Module Data – Fuji 2MBI450VN-120-50

Module Maximum Ratings	Notes	Symbol	min	typ	max	unit
Collector-Emitter Voltage		$V_{ces}$			1200	V
Gate-Emitter Voltage		$V_{ges}$			20	V
Collector Current	Continuous	$I_c$	-300		300	A
Collector Current	Pulse 1ms	$I_{c\_pulse}$	-600		600	A
Collector Power Dissipation	1 Device	$P_c$			2270	W
Junction Temperature	Maximum / Operating	$T_j$			175/150	°C
Isolation Voltage	Terminals to baseplate, 1 min	$V_{iso}$			2500	VAC

IGBT Data	Notes	Symbol	min	typ	max	unit
Collector-Emitter Saturation voltage	$I_c=300A, V_{ge}=15V, T_j = 150^\circ C$	$V_{ce\_sat}$		2.7		V
Parameter for linear model	$T_j = 25^\circ C$	$V_{ce1}$		1.0		V
Parameter for linear model	$T_j = 25^\circ C$	$R_{ce1}$		2.5		mΩ
Parameter for linear model	$T_j = 150^\circ C$	$V_{ce2}$		0.95		V
Parameter for linear model	$T_j = 150^\circ C$	$R_{ce2}$		3.9		mΩ
Thermal resistance junction to case		$R_{thjc}$			.094	K/W
Thermal resistance case to heat sink		$R_{thch}$			.0167	K/W

Diode Data	Notes	Symbol	min	typ	max	unit
Thermal resistance junction to case	For one device	$R_{thjc}$			.1	K/W
Thermal resistance case to heatsink	For one device	$R_{thch}$			.0167	K/W

Collector current vs. Collector-Emitter voltage (typ.)  
 $T_j = 25^\circ C$  / chip

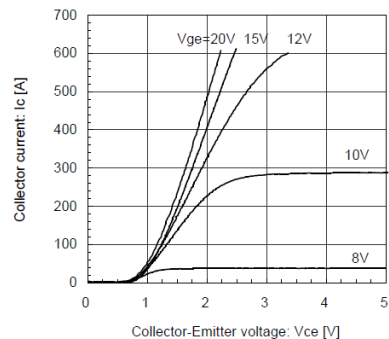

Collector current vs. Collector-Emitter voltage (typ.)  
 $T_j = 150^\circ C$  / chip

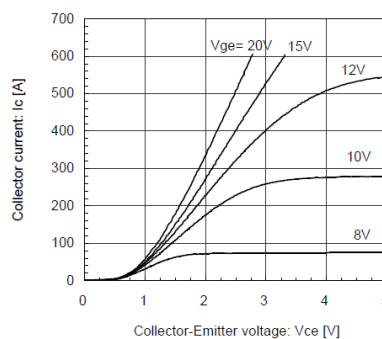

Switching loss vs. Collector current (typ.)  
 $V_{cc}=600, V_{ge}=\pm 15V, R_g=0.93\Omega, T_j=125^\circ C, 150^\circ C$

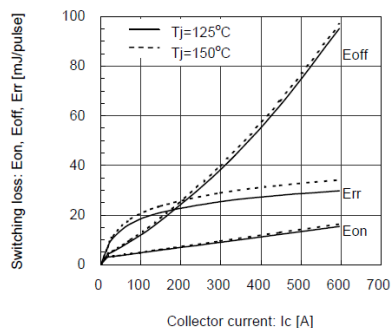

Forward Current vs. Forward Voltage (typ.)  
diode

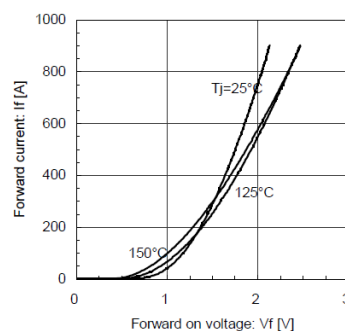

Prepared by: Yueheng Guo

Version: v1.0

Approved by: Albert Charpentier

Effective Date: 2/14/2013

# SmartPower Stacks™ Spec Sheet

## Level 2M: 100 kW DC-AC Inverter

### Controller Interface Data

Data	Notes	Symbol	min	typ	max	unit
Power Voltage Input		$V_{in}$	13	24	30	V
Power Input	$V_{in} = 24V$	$P_{aux}$			30	W
Driver board	See separate datasheet for details	AS2-Econodual Electrical V15 2012-10-26				
Input Signal Logic Hi Level	10kΩ to Gnd, 1nF to GND	$V_{in\_hi}$	11	15	17	V
Input Signal Logic Lo Level		$V_{in\_lo}$	-0.5	.5	2	V
Digital Output Level	Open collector, low=ok, max sink: 15mA	$V_{out}$	0	-	30	V
Analog Output Format	0-10V, max source 15mA					
DC Voltage Measurement range	DC Voltage Corresponds to 0V to +12V analog range Current Output analog voltage is -12V to +12V, e.g. +6V = 450A, -6V = -450A Temperature output voltage is +7.25V to +8.25V, e.g. 100°C = +8V	$V_{dc\_range}$	0	-	1200	V
AC Current Measurement range		$I_{ac\_range}$	-900	-	+900	A
Temperature Measurement range		$T_{range}$	-40	-	150	°C

### Controller/Power to Interface Board (J1) Connectors Data

#### J1 Connector PINOUT Descriptions

Pin No	Signal	Pin No	Signal
1	SHIELD	2	BOT-HB1-IN
3	ERROR-HB1-OUT	4	TOP-HB1-IN
5	BOT-HB2-IN	6	ERROR-HB2-OUT
7	TOP-HB2-IN	8	BOT-HB3-IN
9	ERROR-HB3-OUT	10	TOP-HB3-IN
11	OVERTEMP-OUT	12	RESERVED / OPTIONAL RESET
13	VDC-LINK	14	VCC – +24V Supply Voltage
15	VCC – +24V Supply Voltage	16	+15V
17	+15V	18	GND
19	GND	20	TEMP-SENSE-OUT
21	Aux GND	22	I-SENSE1-OUT
23	Aux GND	24	I-SENSE2-OUT
25	Aux GND	26	I-SENSE3-OUT

#### J1 Connector Hardware

Connector	Type	Manufacturer Part Number
Ribbon Cable	26 Pins	TE Connectivity 1658622-6
Interface Board	26 Pins	TE Connectivity 5499923-6

Prepared by: Yueheng Guo

Version: v1.0

Approved by: Albert Charpentier

Effective Date: 2/14/2013

# SmartPower Stacks™ Spec Sheet

## Level 2M: 100 kW DC-AC Inverter

### Protection / Faults

#### Fault Table

Fault Condition/Action	Generic Sample Default Trigger Values	Action on IGBT if Active
Desat - HI	>7 Volts for 6.1 $\mu$ s*	Turn off HI side
Desat - LO	>7 Volts 6.1 $\mu$ s*	Turn off LO side
HV Overshoot - HI	1080 Volts*	Active Clamping occurs
HV Overshoot - LO	1080 Volts*	Active Clamping occurs
UVLO - HI	<12 Volts	Turn off HI side
UVLO - LO	<12 Volts	Turn off LO side
Cross Latch/Shoot Through	Attempt to turn on both IGBTs simultaneously	Does not allow turn on of inactive IGBT until active is off for 2 $\mu$ s*
DC Link Overvoltage	1000 Volts*	Shut down all IGBTs
Overcurrent	400A	Shut down all IGBTs
Over Temperature	>125C	Shut down all IGBTs

Certain parameters are configurable (noted by \*).

#### Fault Reporting Pins (Configurable)

Fault Condition/Action	Pin 3	Pin 6	Pin 9	Pin 11
DSAT HB1	X			
DSAT HB2		X		
DSAT HB3			X	
OVERCURRENT HB1	X	X	X	
OVERCURRENT HB2	X	X	X	
OVERCURRENT HB3	X	X	X	
TEMP	X	X	X	X
DC LINK OV	X	X	X	
UVLO	X	X	X	

"X" = possible to map this fault to this pin

Note: only 1 fault may be mapped to each pin

Prepared by: Yueheng Guo

Version: v1.0

Approved by: Albert Charpentier

Effective Date: 2/14/2013

# SmartPower Stacks™ Spec Sheet

## Level 2M: 100 kW DC-AC Inverter

### Mechanical Dimensions

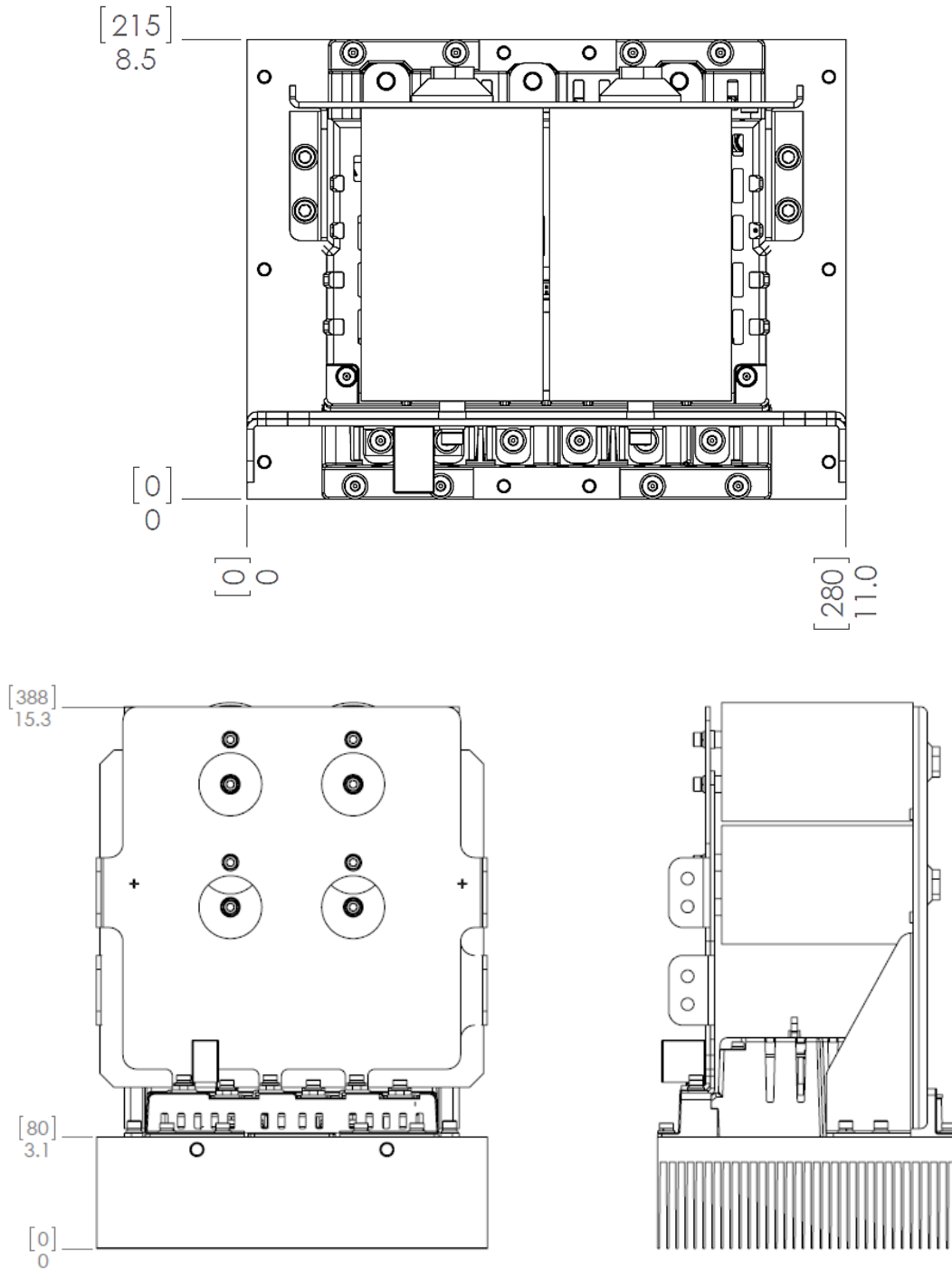

Prepared by: Yueheng Guo

Version: v1.0

Approved by: Albert Charpentier

Effective Date: 2/14/2013

# SmartPower Stacks™ Spec Sheet

## Level 2M: 100 kW DC-AC Inverter

### SmartPower Stack™ Components



Methode Capacitor  
Assembly



AgileSwitch Interface  
Board



AgileSwitch Gate  
Drivers



Fuji IGBTs

LEM Current Sensor



Methode Heat Sink

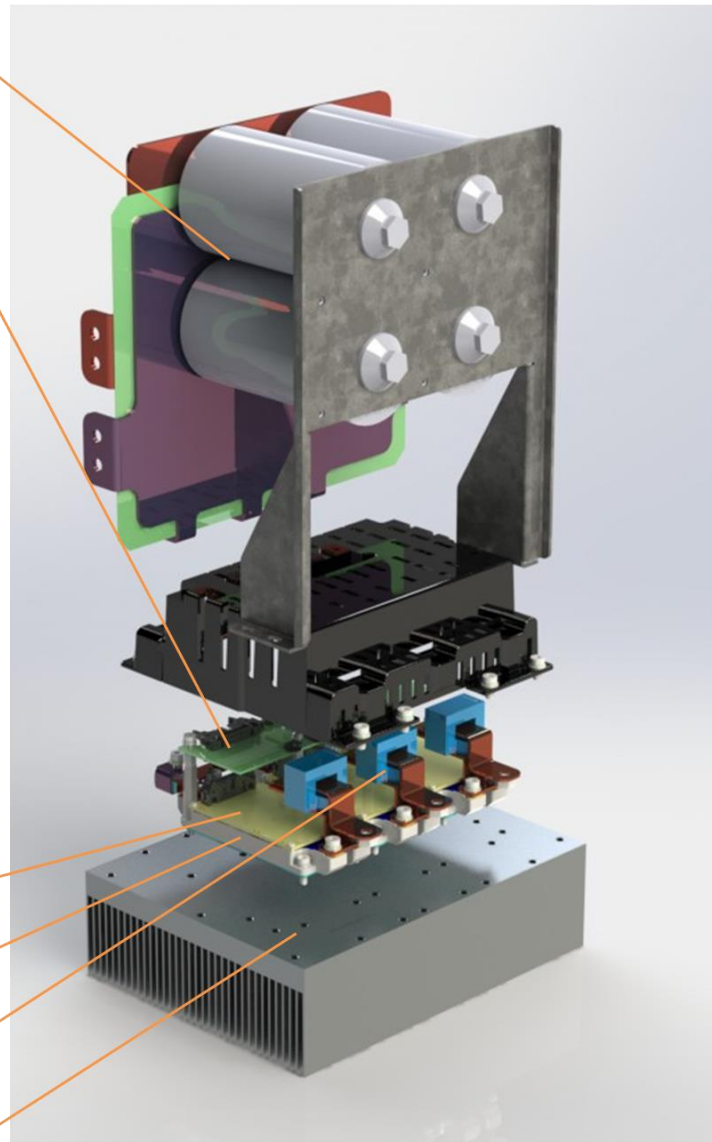

Prepared by: Yueheng Guo

Version: v1.0

Approved by: Albert Charpentier

Effective Date: 2/14/2013

# SmartPower Stacks™ Spec Sheet

## Level 2M: 100 kW DC-AC Inverter

### SmartPower Stack™ Consortium

The SmartPower Stack Consortium consists of global leaders in controllers, IGBTs, gate drives, capacitors, bus bar architectures and cooling solutions that have joined to create the industry's first fully integrated, deployment-ready commercial embedded system for high-volume solar, photovoltaic, wind, hybrid electric and electric vehicles, as well as high capacity uninterruptible power supply and efficient motor drive applications.

As part of this effort, National Instruments supplies the controller, I/O, simulation and programming toolset, SBE provides new high performance wound film capacitors, Fuji supplies industry leading IGBTs, AgileSwitch offers leading edge IGBT gate drives and Methode offers state-of-the-art bus bar architectures, thermal management solutions, assembly and test capability.

Together, the five companies are creating fully integrated sub-system solutions for the power electronics industry with the highest performance for energy conversion inverters and convertor systems. This effort represents the industry's first collaboration of best-in-class technologies that are tightly integrated to deliver smart, efficient, reliable and long lasting power conversion.



7401 West Wilson Avenue  
Chicago, IL 60706-4548  
[www.methode.com](http://www.methode.com)  
[mstibgen@methode.com](mailto:mstibgen@methode.com)



1650 Arch Street, #1905  
Philadelphia, PA 19103  
[www.AgileSwitch.com](http://www.AgileSwitch.com)  
[info@AgileSwitch.com](mailto:info@AgileSwitch.com)



11500 North Mopac Expressway  
Austin, TX 78759  
[www.ni.com](http://www.ni.com)  
[brian.maccleery@ni.com](mailto:brian.maccleery@ni.com)



81 Parker Road  
Barre, VT 05641-9106  
[www.sbelectronics.com](http://www.sbelectronics.com)



50 Northfield Avenue  
Edison, NJ 08837  
[www.americas.fujielectric.com](http://www.americas.fujielectric.com)

### Legal Disclaimer

AGILESWITCH and the AGILESWITCH logo are trademarks or registered trademarks of AGILESWITCH, LLC in various countries. Fuji is trademark of FUJI ELECTRIC CO. Ltd. Methode is trademark of Methode Electronics, INC. SBE and Power Ring Film Capacitors are trademarks of SBE. National Instruments is trademark of National Instruments. SmartPower Stack is trademark of the SmartPower Stack Consortium. Any other names are the property of their respective owners.

Information in this document supersedes and replaces all information previously supplied.

Specifications are subject to change without notice.

© 2010-2013 - All rights reserved.

Prepared by: Yueheng Guo	Version: v1.0
Approved by: Albert Charpentier	Effective Date: 2/14/2013