

# Overcoming Circuit Protection Challenges in Lithium-Ion Battery Packs

## Bourns® Mini-Breakers (Thermal Cutoff Devices)

### APPLICATION NOTE



SA Series



LC Series



HC Series



NR-C Series



NR-A Series

## INTRODUCTION

The potential dangers of lithium-ion batteries have become headline news in recent times. Battery problems in some smartphones, hoverboards and notebooks have highlighted that even the largest of companies may see problems with lithium-ion batteries. Lithium-ion based batteries hold many advantages over competing technologies, with cost being one of the primary advantages. As lithium-ion batteries continue to grow in popularity, they will enjoy further cost reductions because of the economies of scale as they are used in more large applications such as electric vehicles and stationary storage systems. However, the need for protection circuits to maintain the voltage and current within safe limits is one of the primary limitations of the lithium-ion battery.

One of the latest approaches for providing a safety circuit to lithium-ion battery packs is the use of the Bourns® Mini-breaker, which is a resettable Thermal Cutoff (TCO) device designed to provide accurate and repeatable overcurrent and overtemperature protection.

## MINI-BREAKER TECHNOLOGY

The Bourns® Mini-breaker is a combination of two common circuit protection technologies, a PTC and a bimetal switch, providing several advantages over either technology on its own. The skills developed by Bourns over 70 years in precision metal stamping, plastic injection molding and high-end assembly turn these ubiquitous technologies into a market-leading circuit protection solution. Figure 1 below provides a simple schematic of how the mini-breaker is constructed. The two terminals, arm terminal and base terminal, are connected in a normally closed position to allow current to flow through the device. Naturally, the contact point between both terminals provides a critical function and a testament to the high precision of the Bourns® mini-breaker is that the contact resistance is as low as 2 mΩ (max.) in some model families.

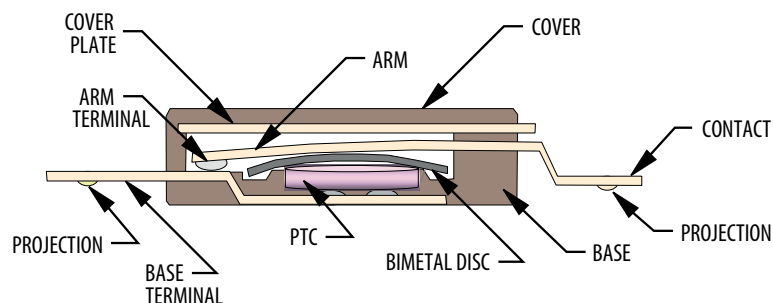

Figure 1. | Construction of the Bourns® Mini-Breaker



# Overcoming Circuit Protection Challenges in Lithium-Ion Battery Packs

## Bourns® Mini-Breakers (Thermal Cutoff Devices) Application Note



SA Series



LC Series



HC Series



NR-C Series



NR-A Series

### HOW THE MINI-BREAKER PROTECTS

Figures 2 and 3 below give an illustration of how the mini-breaker mechanically provides protection to the circuit. In the normal condition, current flows through the arm terminal, down through the very low resistance contact point and out through the base terminal. The key to any battery application is low resistance; hence, the contact resistance between the arm terminal and base terminal is a feature advantage that Bourns has integrated into all of our mini-breaker products.

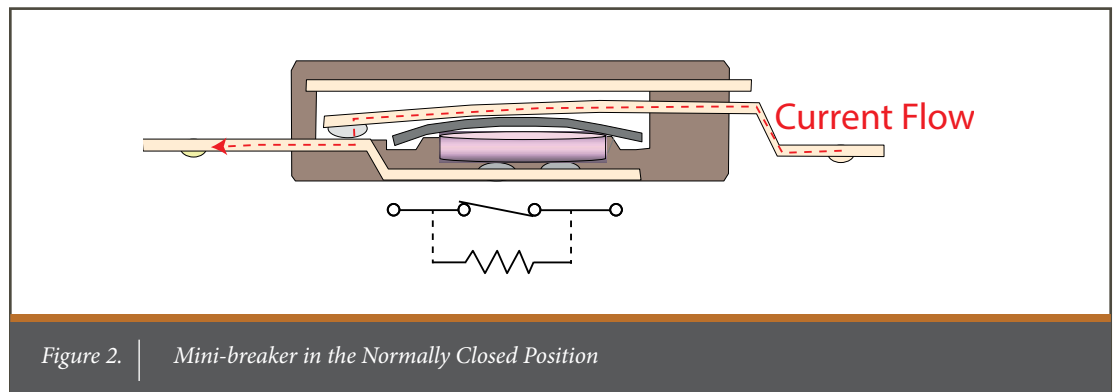

Figure 2. | Mini-breaker in the Normally Closed Position

The mini-breaker can be triggered by either an increase in the environmental temperature or by excessive current flow. Once the trip temperature has been reached, the bimetal disc heats and flexes, causing the arm to open. If the mini-breaker only used a bimetal disc for its protection, the arm would quickly close as temperature cooled. However, key to the mini-breaker's design is the PTC that operates in parallel with the arm terminal. When the bimetal disc causes the arm to open, current flows through the bimetal disc and into the PTC. This current causes the PTC to act like a current limiting heater, which provides sufficient heat to keep the bimetal disc flexed and the arm open. The combination of the bimetal disc and the PTC prevents oscillating opening and closing of the mini-breaker arm. Instead, this design allows the arm to remain open until a lower and safer temperature level of between 40 °C and 10 °C below the lower specification limit of the mini-breaker is reached, at which point the arm will reset. As part of UL 60730 testing, Bourns® mini-breakers are tested up to 6000 cycles of this opening and closing mechanism.

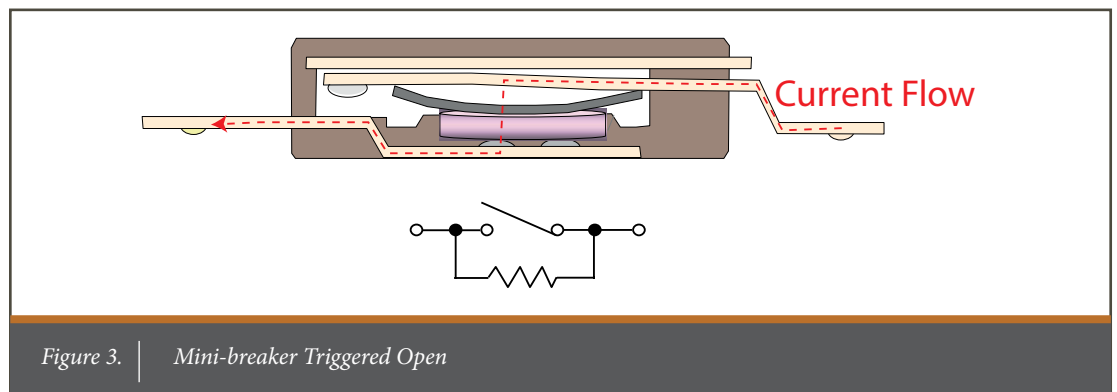

Figure 3. | Mini-breaker Triggered Open



# Overcoming Circuit Protection Challenges in Lithium-Ion Battery Packs

## Bourns® Mini-Breakers (Thermal Cutoff Devices) Application Note



### HOW THE MINI-BREAKER PROTECTS (Continued)

A graphical representative of the relation between ambient temperature and the mini-breaker TCO operation is outlined in figure 4.

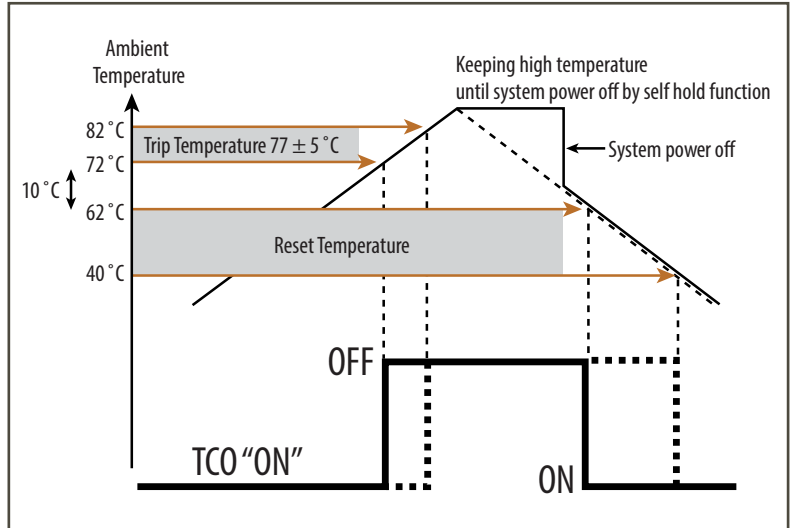

Figure 4. Relationship between Trip/Reset Temperature and Bourns® Mini-breaker TCO Operation

### APPLICATIONS FOR MINI-BREAKERS

Mini-breakers typically come in an axial leaded format to allow the device to be welded to the terminals of the battery cells. The battery cell terminals are typically made from aluminum tabs so the mini-breakers are usually welded to nickel tabs before those nickel tabs are welded to the battery cell terminals. The advantage of welding the mini-breakers close to the battery tabs is that the mini-breakers can be situated in intimate contact with the individual battery cells and can react quickly to any unusual rises in cell temperature.

Today, mini-breakers are commonly used to protect the battery cells of notebook PCs, tablet computers, smartphones and digital cameras. As each battery pack is customized to fit the limited space within the portable electronic device, the mini-breaker is welded to nickel tabs of various sizes and formats.

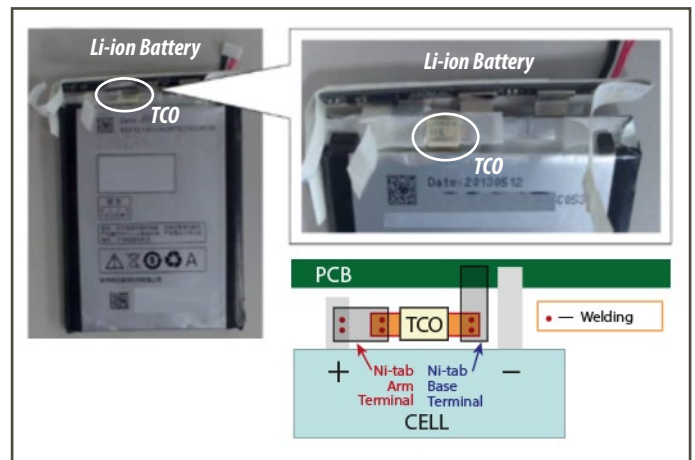

Figure 5. Mini-breaker TCO Devices in Battery Cell Protection Circuit





# Overcoming Circuit Protection Challenges in Lithium-Ion Battery Packs

## Bourns® Mini-Breakers (Thermal Cutoff Devices) Application Note



SA Series



LC Series



HC Series



NR-C Series



NR-A Series

### KEY MINI-BREAKER SPECIFICATIONS

The trip temperature of the mini-breaker is a key specification to battery pack manufacturers and Bourns has developed the ability to target specific trip temperature values. The combination of both the composite bimetal material and the precision forming of the bimetal disc allows Bourns® mini-breakers to target trip temperatures from 72 °C to 90 °C within a ±5 °C accuracy. These tolerances can be further fine-tuned.

Mini-breakers trigger from a combination of temperature and current. The ambient temperature will rise from the I<sup>2</sup>R Joule heating (or resistive heating) caused by the interactions of the electrons from the electric current and the atomic ions in the terminals. Consequently, mini-breakers at lower ambient temperatures can hold significantly higher currents than mini-breakers at higher ambient temperatures. The graph in figure 6 gives an illustration of the ambient current impact on operating currents of various Bourns® mini-breaker models.

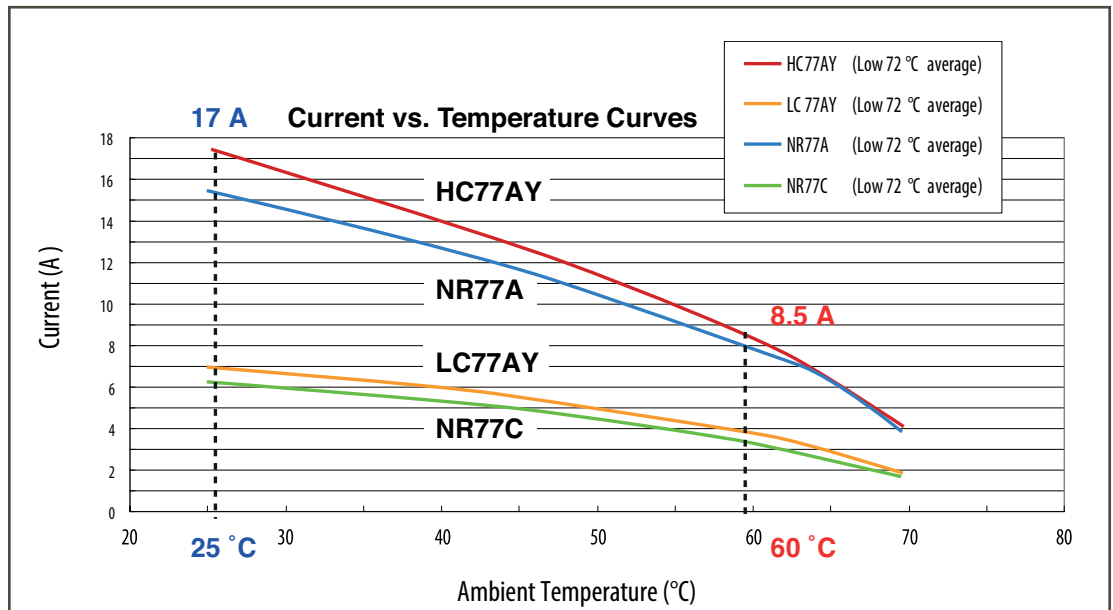

Figure 6. Ambient Temperature Impact on Mini-breaker Operating Currents

Within the various Bourns® TCO device series, there are individual models that feature different trip temperatures where the higher the trip temperatures, the higher the operating currents. This is illustrated in figure 7, which shows that in the Model HC series, the Model HC90 can hold significantly higher currents than the Model HC72.



# Overcoming Circuit Protection Challenges in Lithium-Ion Battery Packs

## Bourns® Mini-Breakers (Thermal Cutoff Devices) Application Note



### KEY MINI-BREAKER SPECIFICATIONS (Continued)

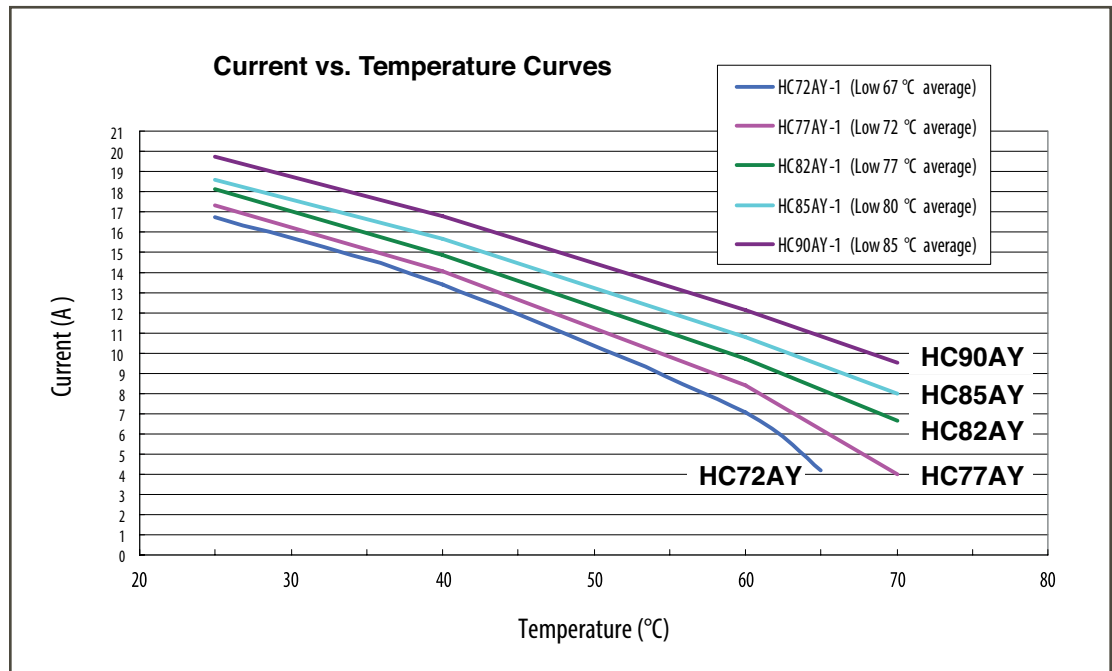

Figure 7. Ambient Temperature Impact on Operating Currents within the Same Series

The maximum leakage current is a specification determined by the PTC. When the mini-breaker opens, it does not cut the current as the current path changes and now travels through the parallel circuit of the bimetal disc and PTC. The PTC has an internal resistance that is used to heat the bimetal disc and the leakage current is a result of the PTC let-through current.

In order to keep the mini-breaker in the latched (open) position, the PTC requires a minimum voltage to generate sufficient heat. This is the source of the “self-hold minimum voltage” specification in the mini-breaker data sheet, which typically ranges from 2 V up to 3.5 V.



# Overcoming Circuit Protection Challenges in Lithium-Ion Battery Packs

## Bourns® Mini-Breakers (Thermal Cutoff Devices) Application Note



SA Series



LC Series



HC Series



NR-C Series



NR-A Series

### MINI-BREAKER EVOLUTION

Mini-breaker TCO devices come in two distinct formats:

- Axial leaded packaging, such as Bourns® Models HC, LC, NR & AA Series
- Surface mount packaging, illustrated by Bourns® Model SA Series

The axial leaded models are the most common mini-breaker TCOs on the market. They are almost exclusively used in lithium-ion battery packs and are welded into place using secondary nickel tabs. Bourns® Model LC Series is one of the most popular models of this type on the market.

Three evolutionary advancements have come out of the Bourns® Model LC series:

- 1. Higher Currents** – As higher current density batteries grow in popularity, whether for electric vehicles, home energy storage or electric bicycles, mini-breakers are being asked to handle higher currents. This trend has led to the Bourns® Model AA series, which can operate up to 14 A at 60 °C with future devices under development with even higher current-handling capabilities.
- 2. Smaller Footprints** – Portable electronics continue to shrink in footprint and thickness. Electronics have become wearable and are now in intimate contact with the human body. This has led to a need for greater levels of safety and smaller sizes. Bourns introduced the Model NR series, one of the smallest mini-breakers in the market. This is an ongoing trend, and Bourns will continue to develop smaller-size mini-breaker models without sacrificing performance.
- 3. Surface Mount** – Mini-breakers are traditionally resistance welded into the battery pack. However, this has limited its uses in other applications. Bourns® Model SA Series is the industry's first surface mount mini-breaker. This TCO series expands usage into markets such as USB cables, automotive and consumer board electronics. The demand for these surface mount devices is a result of the combination of the higher current and smaller footprint trends mentioned above where they will need to hold greater levels of current and shrink in size.



# Overcoming Circuit Protection Challenges in Lithium-Ion Battery Packs

## Bourns® Mini-Breakers (Thermal Cutoff Devices) Application Note



SA Series



LC Series



HC Series



NR-C Series



NR-A Series

### CONCLUSION

As lithium-ion battery pack applications continue to grow in use and sophistication, so too must the safety circuits to match these demands. Bourns® mini-breaker TCO products have been proven over numerous years in a multitude of applications with an installed base of more than 2.7 billion units sold. Bourns is committed to maintaining the highest levels of performance and quality as the foundation for innovating future generations of mini-breaker TCO products that continue to meet the demand for higher currents, smaller sizes and surface mount formats.

### ADDITIONAL RESOURCES

Please contact your local Bourns Application Engineer or Bourns Sales Representative for additional information.

Visit Bourns online at:

[www.bourns.com](http://www.bourns.com)



COPYRIGHT © 2017 • BOURNS, INC. • 04/17 • e/KLM1708

\*Bourns® is a registered trademark of Bourns, Inc. in the U.S. and other countries.

**Americas:** Tel +1-951 781-5500  
Fax +1-951 781-5700

**EMEA:** Tel +36 88 520 390  
Fax +36 88 520 211

**Asia-Pacific:** Tel +886-2 256 241 17  
Fax +886-2 256 241 16